

TWO-PIECE SHIELDS

SGH-44,97x44,97x2,00x0,15-FS-C

SGH-44,37x44,37x9,75x0,20-FS-F

COVER

SGH-44,97x44,97x2,00x0,15-FS-C

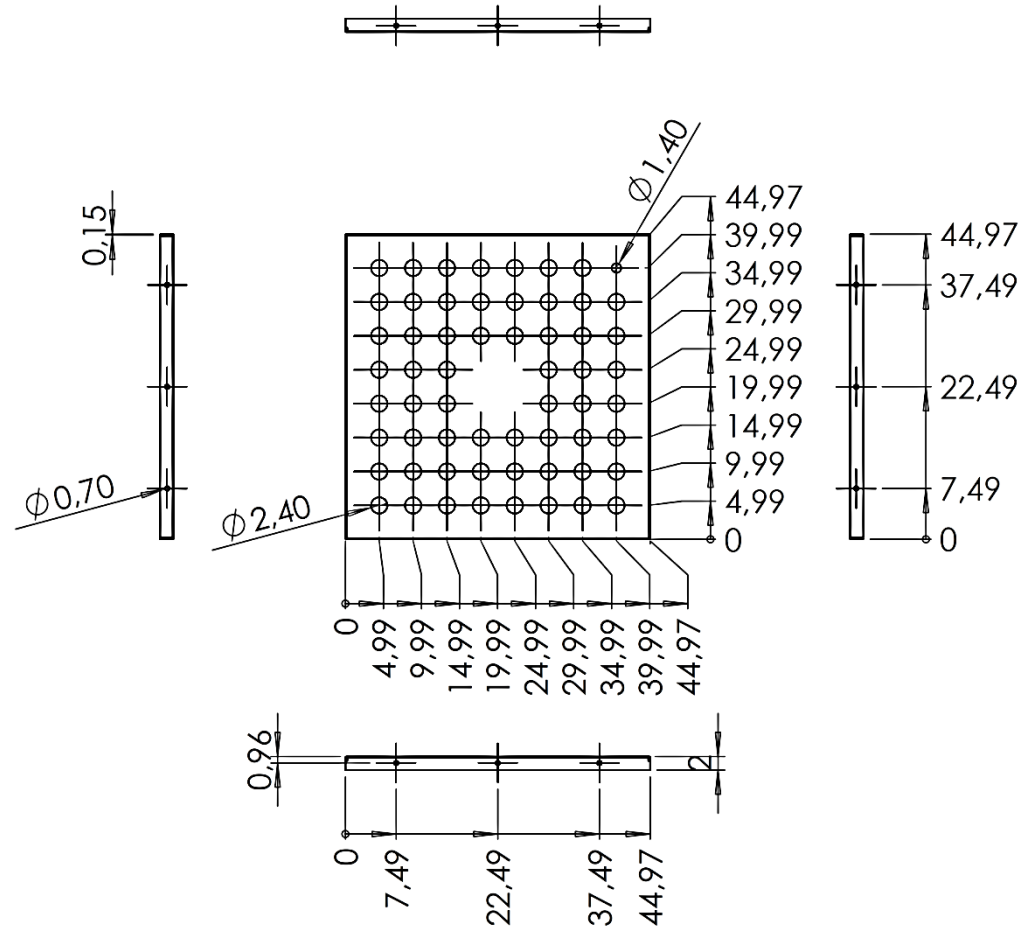
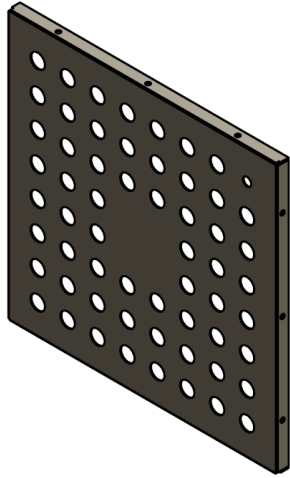

Property	Value	Tolerance
Thickness	0,15 mm	ISO 2768-mK
Length	44,97 mm	ISO 2768-mK
Width	44,97 mm	ISO 2768-mK
Height	2,00 mm	ISO 2768-mK
Material	SPTE	
Plating	Tin-plated	

TWO-PIECE SHIELDS

SGH-44,97x44,97x2,00x0,15-FS-C

SGH-44,37x44,37x9,75x0,20-FS-F

PACKING SPECIFICATION – TRAY (mm)

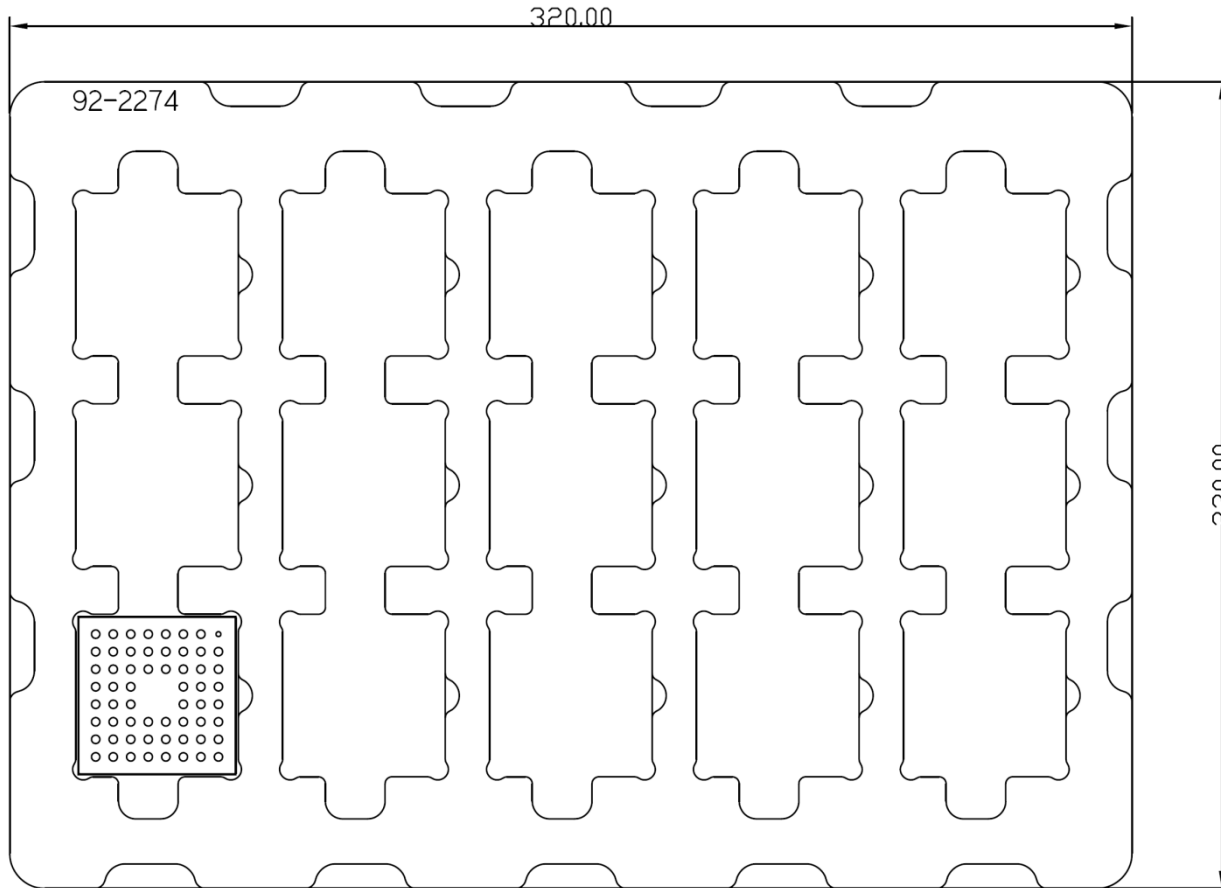

- Material: white PS
- Tolerances: $\pm 0,30$ to $\pm 0,50$ mm

TWO-PIECE SHIELDS

SGH-44,97x44,97x2,00x0,15-FS-C

SGH-44,37x44,37x9,75x0,20-FS-F

FRAME

SGH-44,37x44,37x9,75x0,20-FS-F

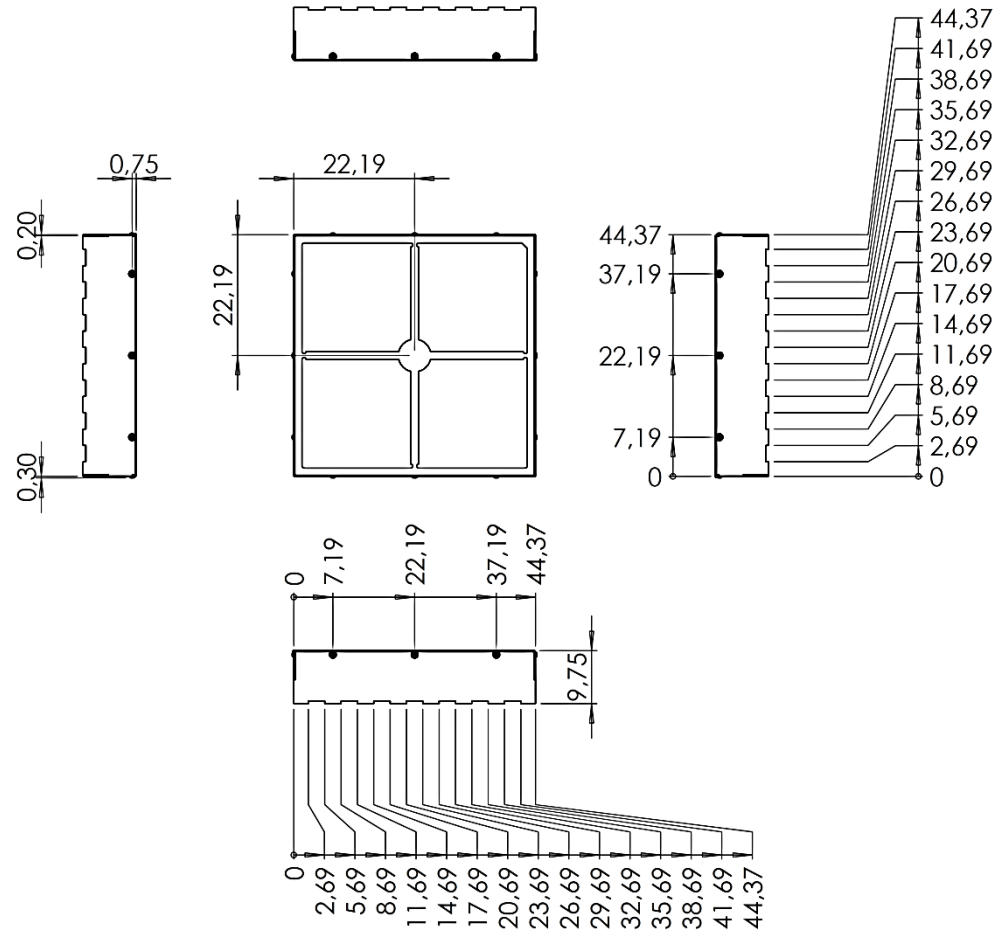
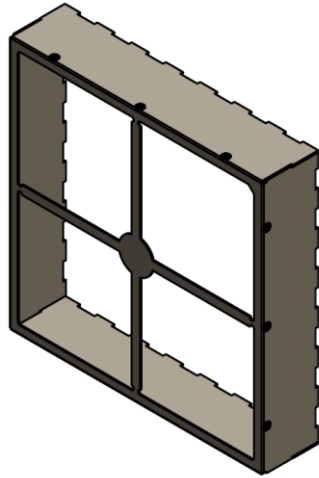

Property	Value	Tolerance
Thickness	0,20 mm	ISO 2768-mK
Length	44,37 mm	ISO 2768-mK
Width	44,37 mm	ISO 2768-mK
Height	9,75 mm	ISO 2768-mK
Material	SPTE	
Plating	Tin-plated	

TWO-PIECE SHIELDS

SGH-44,97x44,97x2,00x0,15-FS-C

SGH-44,37x44,37x9,75x0,20-FS-F

RECOMMENDED FOOTPRINT (mm)

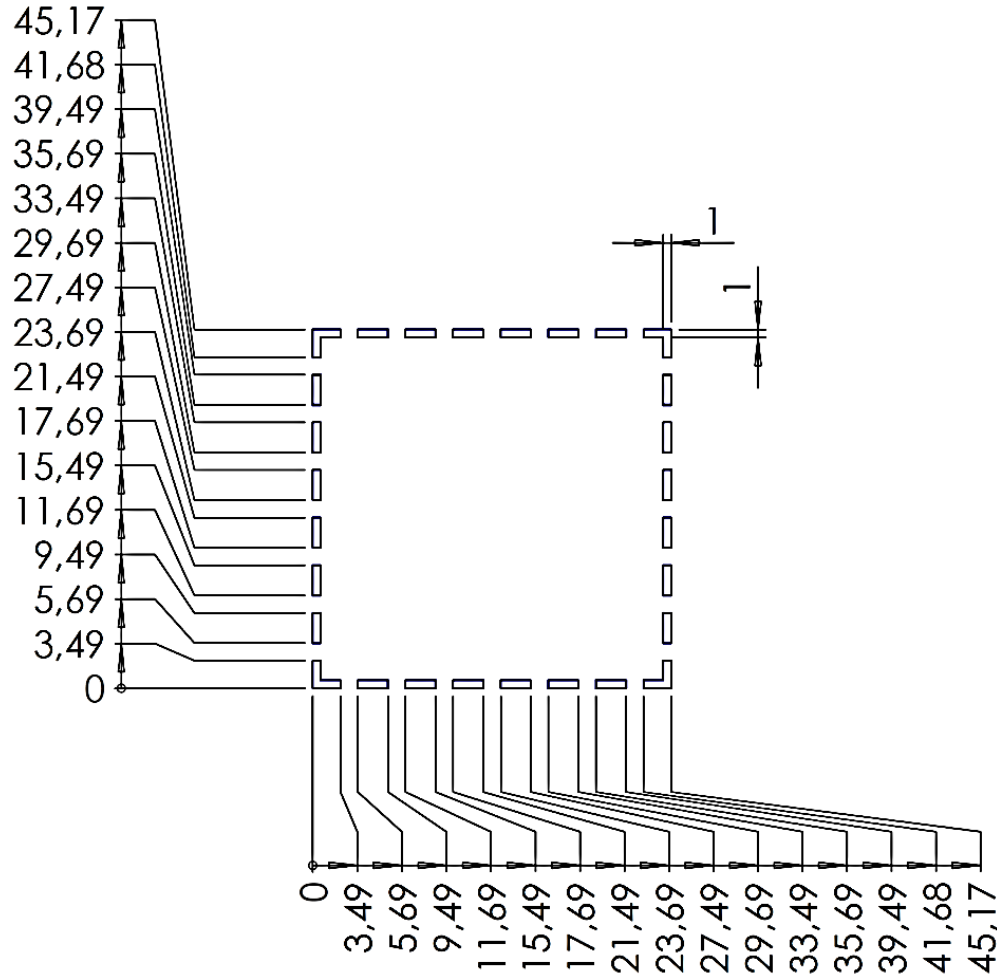

Disclaimer: This is only a recommendation based on information available to **mtc** at the time of printing. Actual land pattern can be significantly different due to various materials and processes used in PCB assembly. **mtc** makes no representation or warranty of performance based on the recommended land pattern.

TWO-PIECE SHIELDS

SGH-44,97x44,97x2,00x0,15-FS-C

SGH-44,37x44,37x9,75x0,20-FS-F

PACKING SPECIFICATION – TAPE AND REEL (mm)

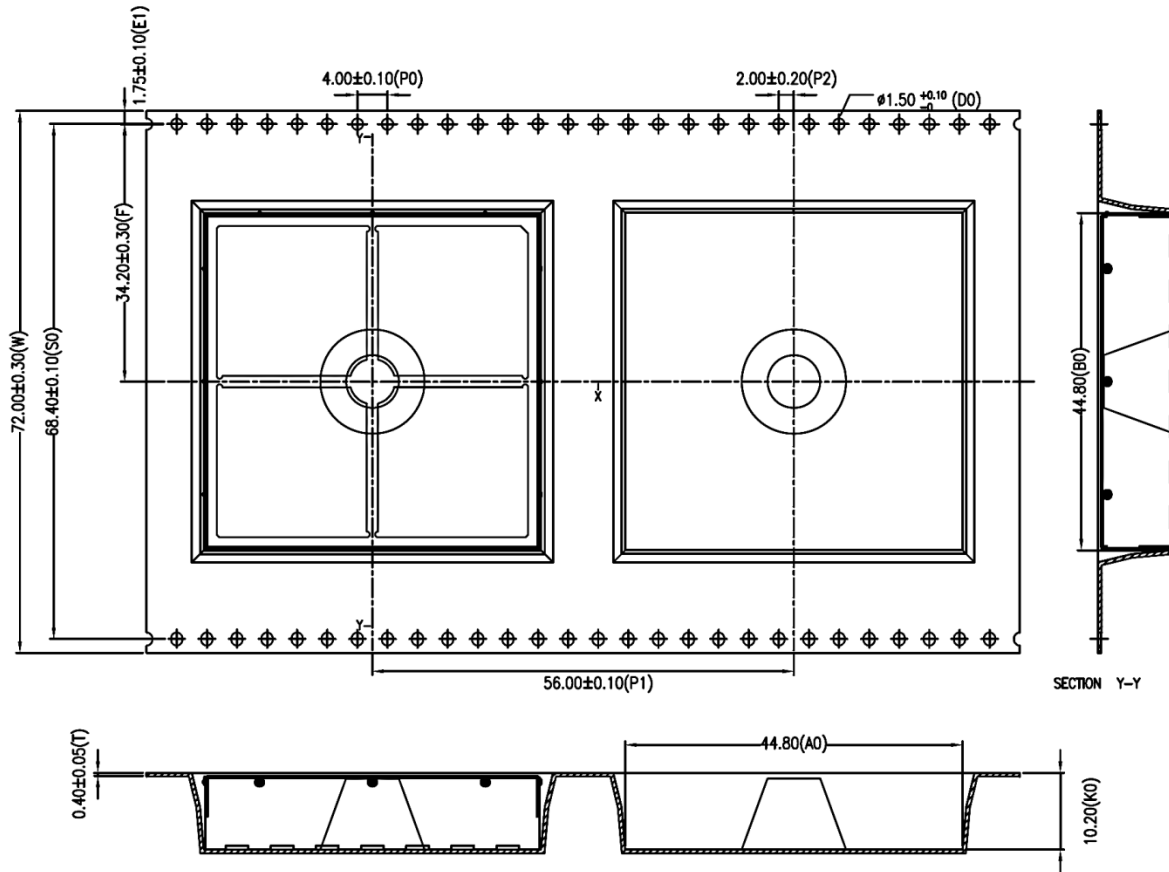

- Part conforms to EIA-481-D standards.
- Material: conductive polystyrene
- Packing length for 22" reel: 23,0 meters (1:4).
- Component packing to 13" reel: 80 pcs.
- Dimension tolerances:
 - .X \pm 0,20
 - .XX \pm 0,10

	A ₀	B ₀	K ₀
	44,80	44,80	10,20
Tolerance	$\pm 0,10$	$\pm 0,10$	$\pm 0,10$