

ACTF4186,422.5-DCC6 Features:

- Low-loss RF filter for CDMA450 – Block L
- High Rejection
- Single Ended Operation at 50Ω without Matching
- Ceramic Package for Surface Mounted Technology (SMT)
- Lead-free Production and RoHS Compliance

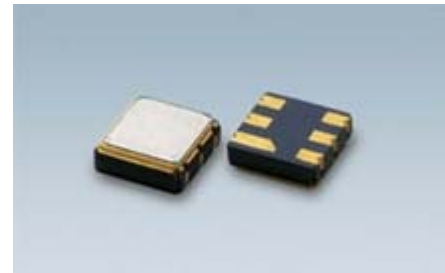

Package Dimensions

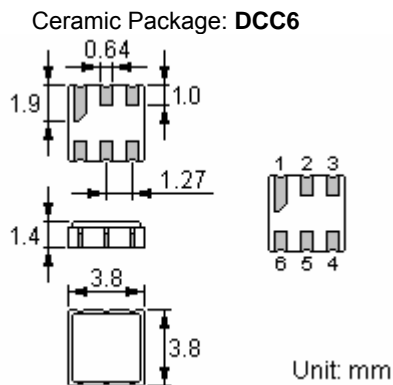

Pin Configuration

2	Input
5	Output
1, 3, 4, 6	Case Ground
1, 3, 4, 6	To Be Grounded

Marking



Top View, Laser Marking

- "ACT": Manufacturer's mark "F": SAW filter
 "4186": Part number "·": Terminal 1
 "*": Lot number (The code shown below varies in a 4-year cycle)

Code	1	2	3	4	5	6	7	8	9	10	11	12
2005	A	B	C	D	E	F	G	H	J	K	L	M
2006	N	P	Q	R	S	T	U	V	W	X	Y	Z
2007	a	b	c	d	e	f	g	h	i	j	k	m
2008	n	p	q	r	s	t	u	v	w	x	y	z

Maximum Ratings

Rating		Value	Unit
Operating Temperature Range	T_A	-40 ~ +85	°C
Storage Temperature Range	T_{stg}	-40 ~ +85	°C
DC Voltage (between any Terminals)	V_{DC}	0	V
RF Power (in BW)	P	26max.	dBm
ESD Voltage (HB)	V_{ESD}	150	V

In line with our ongoing policy of product evolution and improvement, the above specification may subject to change without notice

ISO9001:2000 Registered

For quotations or further information please contact us at:

3 The Business Centre, Molly Millars Lane, Wokingham, Berkshire, RG41 2EY, UK

<http://www.actcrystals.com>

Electrical Characteristics (-30°C~ +85°C)

Item		Minimum	Typical	Maximum	Unit
Center Frequency	f_c	-	422.50	-	MHz
Maximum Insertion Loss in 420.0 ~ 425.0 MHz	IL	-	2.6	3.5	dB
Absolute Attenuation	α				
0.30 ... 410.00 MHz		40	45	-	dB
410.00 ... 415.00 MHz		40	48	-	dB
442.50 ... 465.00 MHz		35	45	-	dB
465.00 ... 1000.0 MHz		40	45	-	dB
1000.0 ... 2000.0 MHz		25	30	--	dB
Passband Ripple	$\Delta\alpha$		0.8	2.0	dB
420.0 ~ 425.0 MHz					
Group Delay Variation			60	150	ns
420.0 ~ 425.0 MHz					
Input VSWR in 420.0 ~ 425.0 MHz		-	1.6:1	2.0:1	
Output VSWR in 420.0 ~ 425.0 MHz		-	1.6:1	2.0:1	
Source / Load Impedance (single ended)			50		Ω

 **RoHS Compliant**

 **Electrostatic Sensitive Device**

Typical Frequency Response

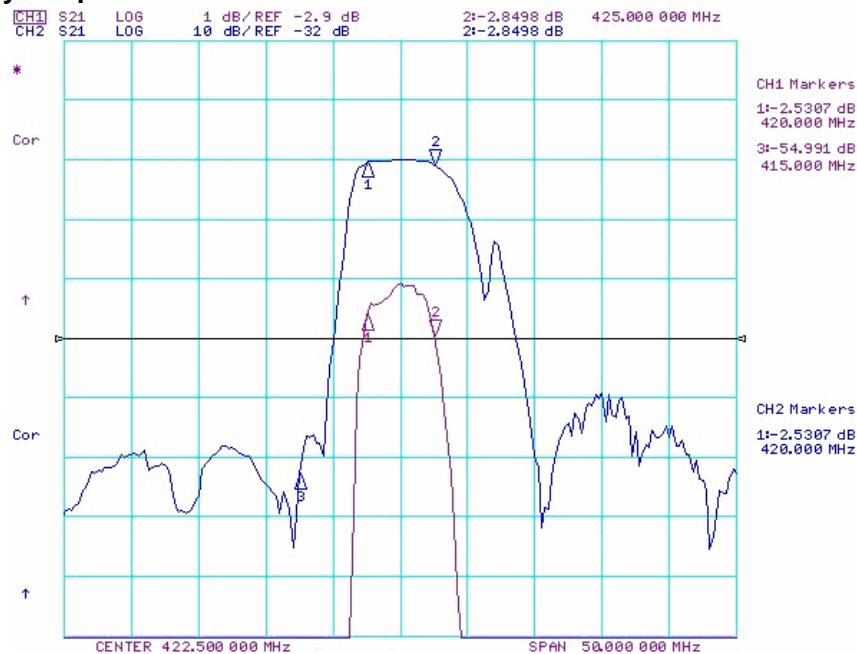

In line with our ongoing policy of product evolution and improvement, the above specification may subject to change without notice

ISO9001:2000 Registered

For quotations or further information please contact us at:

3 The Business Centre, Molly Millars Lane, Wokingham, Berkshire, RG41 2EY, UK

<http://www.actcrystals.com>

Stability Characteristics

	Test item	Condition of test
1	Mechanical shock	(a) Drops: 3 times on concrete floor (b) Height: 1.0 m
2	Vibration resistance	(a) Frequency of vibration: 10~55Hz (c) Directions: X,Y and Z (b) Amplitude: 1.5 mm (d) Duration: 2 hours
3	Moisture resistance	(a) Condition: 40°C, 90~95% R.H. (c) Wait 4 hours before measurement (b) Duration: 96 hours
4	Climatic sequence	(a) +70°C for 16 hours (c) -25°C for 2 hours (e) Wait 4 hours before measurement (b) +55°C for 24 hours, 90~95% R.H. (d) +40°C for 24 hours, 90~95% R.H.
5	High temperature exposure	(a) Temperature: 70°C (c) Wait 4 hours before measurement (b) Duration: 250 hours
6	Thermal impact	(a) +70°C for 30 minutes ⇒ -25°C for 30 minutes repeated 3 times (b) Wait 4 hours before measurement

Requirements: The SAW filer shall remain within the electrical specifications after tests.

Remarks

- SAW devices should not be used in any type of fluid such as water, oil, organic solvent, etc.
- Be certain not to apply voltage exceeding the rated voltage of components.
- Do not operate outside the recommended operating temperature range of components.
- Sudden change of temperature shall be avoided, deterioration of the characteristics can occur.
- Be careful of soldering temperature and duration of components when soldering.
- Do not place soldering iron on the body of components.
- Be careful not to subject the terminals or leads of components to excessive force.
- SAW devices are electrostatic sensitive. Please avoid static voltage during operation and storage.
- Ultrasonic cleaning shall be avoided. Ultrasonic vibration may cause destruction of components.

Test Circuit

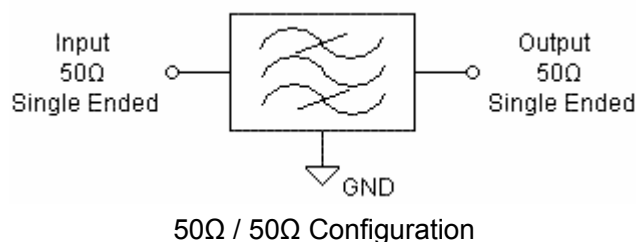

Recommended Land Pattern

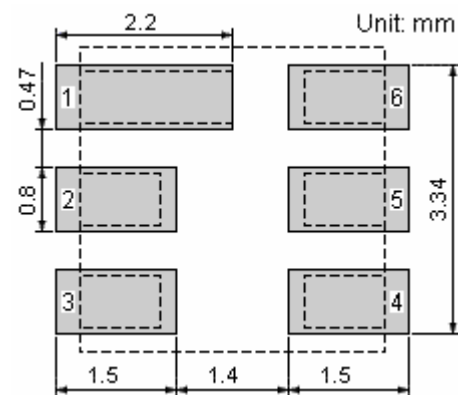

In line with our ongoing policy of product evolution and improvement, the above specification may subject to change without notice

ISO9001:2000 Registered

For quotations or further information please contact us at:

3 The Business Centre, Molly Millars Lane, Wokingham, Berkshire, RG41 2EY, UK

<http://www.actcrystals.com>

Packing Information

Carrier Tape

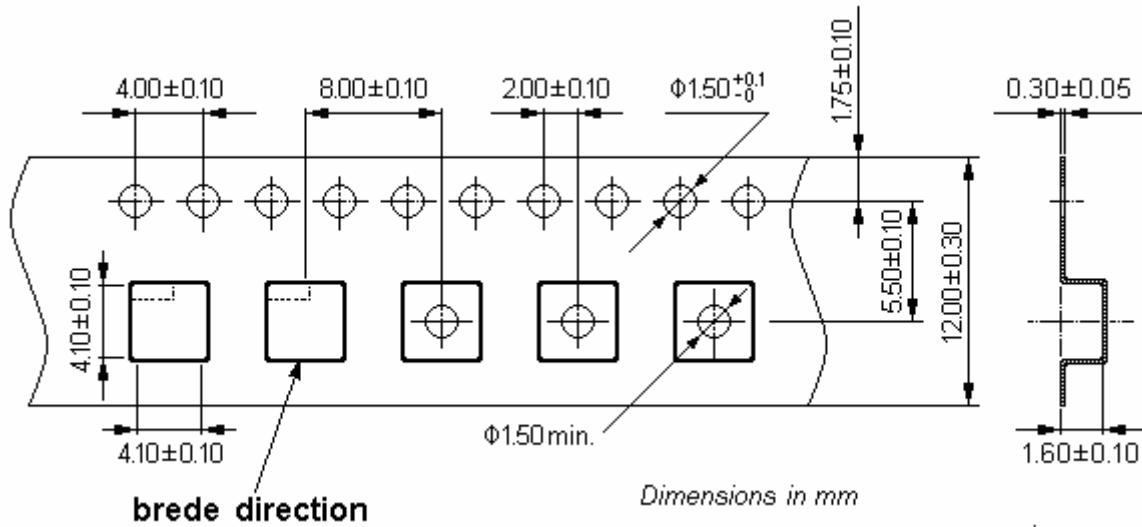

Reel Dimensions

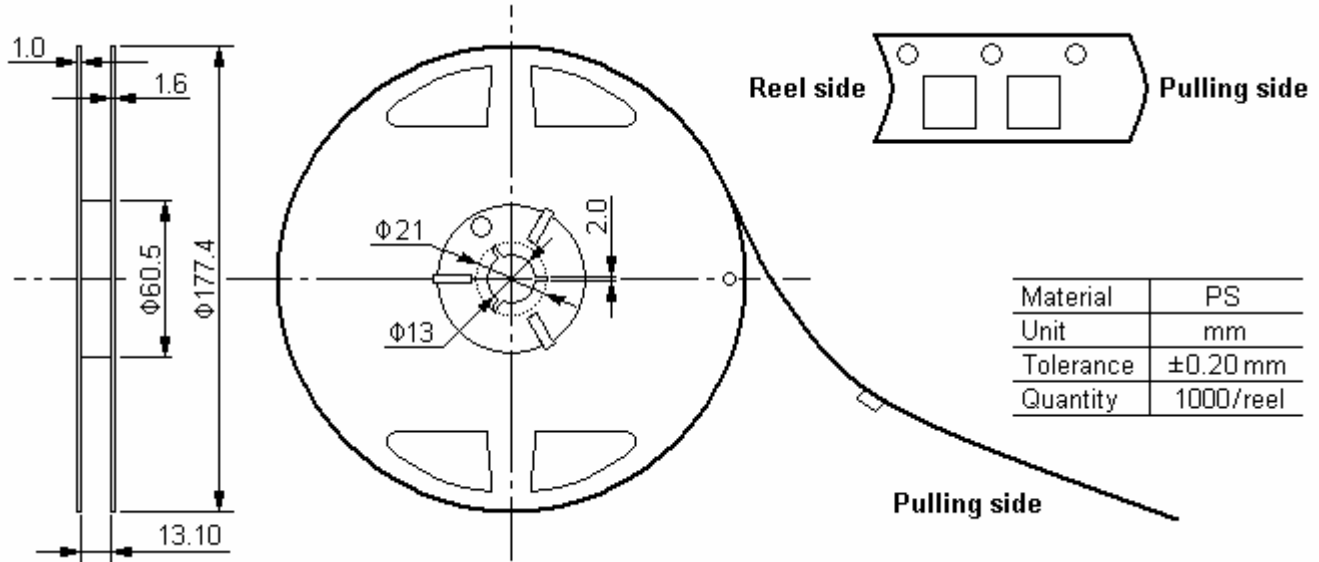

Outer Packing

Type	Quantity	Dimension	Description	Weight
Carton Box I	5000	190×190×95	anti-static plastic bag & carton box 1 reel / bag	0.85
Carton Box II	10000	190×190×190	5 bags / box (5000 pcs) 10 bags / box (10000 pcs)	1.70

Unit: mm

Unit: kg

In line with our ongoing policy of product evolution and improvement, the above specification may subject to change without notice

ISO9001:2000 Registered

For quotations or further information please contact us at:

3 The Business Centre, Molly Millars Lane, Wokingham, Berkshire, RG41 2EY, UK

<http://www.actcrystals.com>

Recommended Soldering Profile

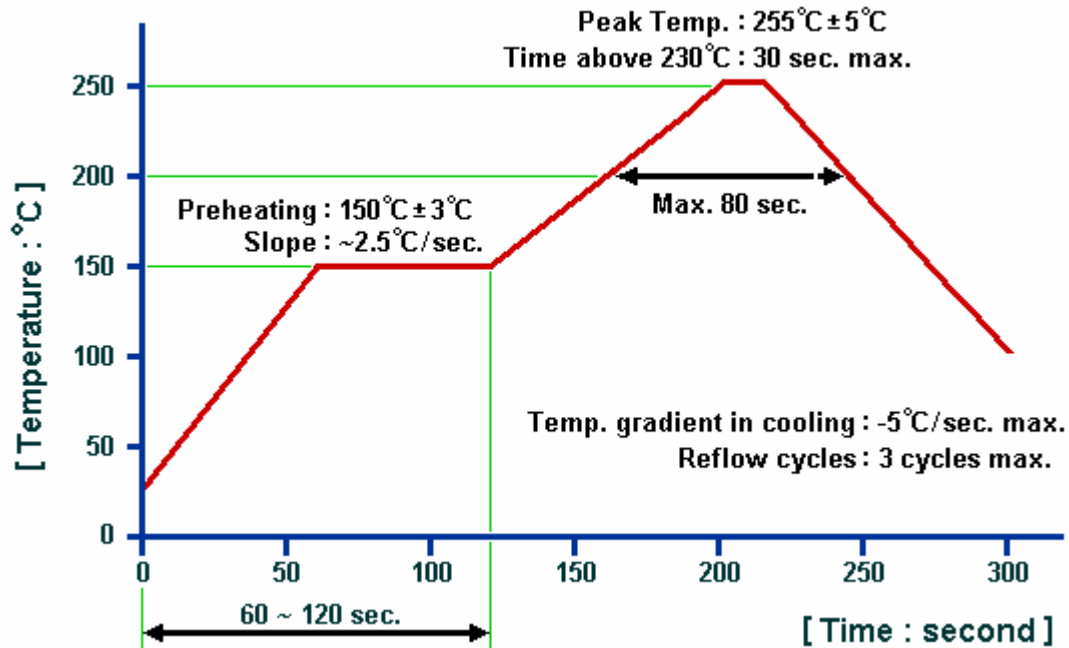

1. The specifications of this device are subject to change or obsolescence without notice.
2. Typically, equipment utilizing this device requires emissions testing and government approval, which is the responsibility of the equipment manufacturer.
3. Our liability is only assumed for the Surface Acoustic Wave (SAW) component(s) per se, not for applications, processes and circuits implemented within components or assemblies.

In line with our ongoing policy of product evolution and improvement, the above specification may subject to change without notice

ISO9001:2000 Registered

For quotations or further information please contact us at:

3 The Business Centre, Molly Millars Lane, Wokingham, Berkshire, RG41 2EY, UK

<http://www.actcrystals.com>